



AW3707-E-F

Common Name 24 Port, AltaFlex, Low Band, Mid Band Tri-Sector w/ Adjustable Azimuth of +/- 10°

698-960MHz	12	eRET	12.4	65°
1710-2690MHz	12	eRET	17.8	65°
Frequency	Ports	Tilt	Gain	Beamwidth

PRODUCT INFORMATION

This antenna solution is being deployed on roofs and macro pole applications globally. The Adjustable Sector Azimuth enables sectors to be rotated by up to +/- 10° off the typical fixed azimuths of 0° , 120° and 240°. It is a multi-frequency solution. Designed for compact, aesthetically pleasing applications.

APPLICATION

Canisters support multiple antennas into one attractive package. These canisters deliver an elegant macro solutions for pole-top, rooftop and streetworks applications. Alpha Wireless produces the highest performance, smallest diameter canister in the marketplace. This Canister solution provides a +/- 10° adjustable Azimuth.

STANDARD & CERTIFICATIONS

Certification	BS EN ISO 9001:2015
---------------	---------------------



FEATURES

- Individual sectors may be rotated in azimuth plane by up to +/- 10° by mechanical adjustment.
- Multi-band Tri-Sector antenna - 698-960/1710-2690MHz
- Low PIM performance to reduce interference
- Independent tilt on each band
- Flange mount design

The parameters in this specification follow the definitions and recommendations per NGMN P-Basta, Release 9.6.

TECHNICAL SPECIFICATION

Electrical Specifications							
Frequency Range	MHz	698-790	790-890	890-960	1710-1920	1920-2170	2300 - 2690
Polarisation	Degree	+/-45° Slant Linear					
Gain							
Basta	dBi	11.7±0.5	11.8±0.5	11.9±0.5	16.8±0.5	17.1±0.5	17.3±0.5
Max	dBi	12.2	12.3	12.4	17.3	17.6	17.8
Azimuth Beamwidth	Degree	69°	67°	65°	69°	64°	60°
Azimuth Beam Squint	Degree<	3°					
Elevation Beamwidth	Degree	26°	25°	23°	6.5°	6.2°	6.0°
Electrical Downtilt	Degree	T6° - T14°			T0° - T10°		
Electrical Downtilt Deviation	Degree<	1°					
Impedance	Ohms	50					
VSWR	<	1.5					
Return Loss	dB>	14					
Isolation	dB>	25					
Passive Intermodulation	dBc<	-150					
Upper Sidelobe Suppression, Peak to 20°	dB>	N/A			16		
Cross-Polar Discrimination	dB>	16			15		
Maximum Effective Power Per Port	W	500			250		

Representative Pattern Files

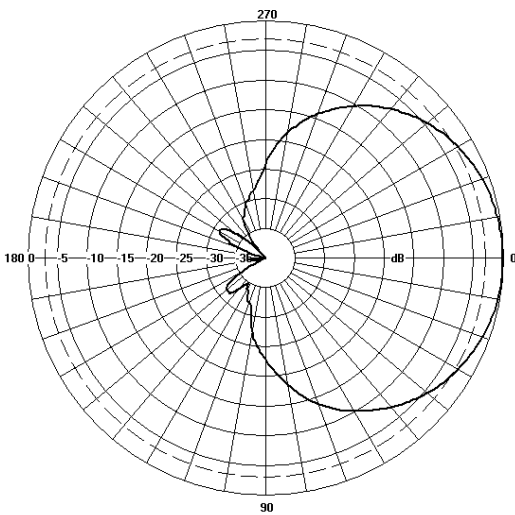

Azimuth

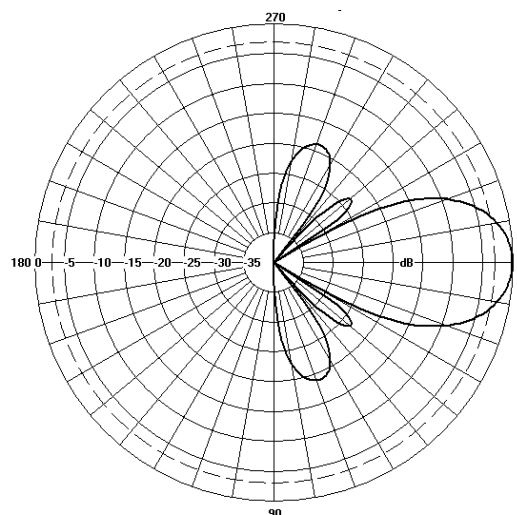

Low Band

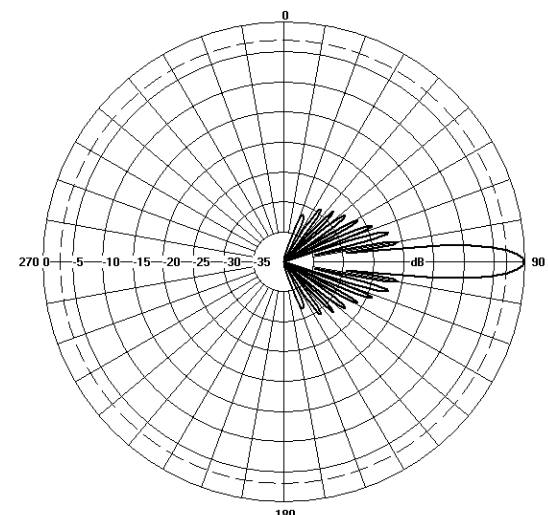

Ultra-wide Band

Elevation

For radiation pattern files, please login at www.alphawireless.com

TECHNICAL SPECIFICATION

Mechanical Specifications

Dimensions	mm (in)	4100 (161.4) x 406 (16) - (L x Ø)
Net Weight (antenna)	kg (lb)	157.5 (346.5)
Net Weight (mount)	kg (lb)	Flange mount
Shipping Weight	kg (lb)	222.5 (490)
Connector Type (Female)	-	4.3-10
Connector Position	-	Bottom
Connector Quantity	-	24 (12P Low Band, 12P High band)
Windload Frontal (at Rated Wind Speed: 150km/h)	N (lbf)	1375 (309)
Windload Lateral (at Rated Wind Speed: 150km/h)	N (lbf)	1375 (309)
Survival Wind Speed	km/h (mph)	200 (125)
Radome Material	-	UV-Stabilised ABS Capped ASA
Radome Colour	RAL	7035 (light grey)
Product Compliance Environmental	-	RoHS
Lightning Protection	-	DC Grounded
Cold Temperature Survival	Celsius (Fahrenheit)	-40 (-40)
Hot Temperature Survival	Celsius (Fahrenheit)	70 (158)

Array Layout and RET Information

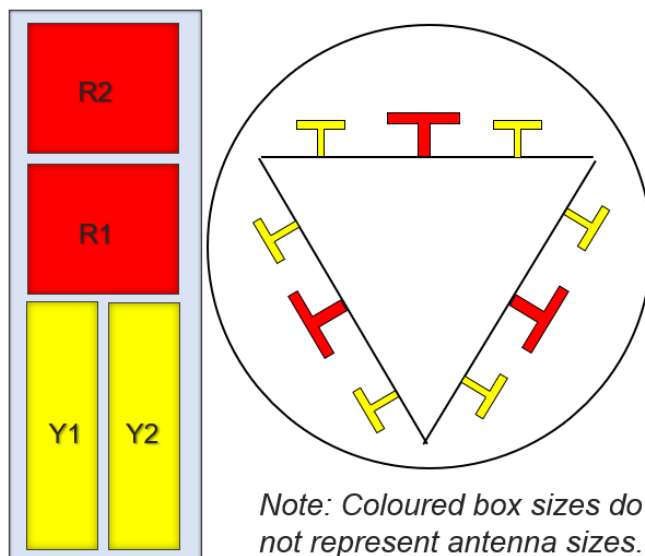

Array	Frequency MHz	Ports	RET ID
R1	698 - 960	1 - 2	1
R2	698 - 960	3 - 4	2
Y1	1710 - 2690	5 - 6	3
Y2	1710 - 2690	7 - 8	4

Configuration	
698 - 960 MHz	One RET for each array: R1, R2
1710 - 2690 MHz	One RET for each array: Y1, Y2
Total Quantity	Twelve RET Motor Controllers
Location and Interface	
RET Controller Location	Inside antenna radome housing
RET Interface	Pair of AISG 8 Pin DIN connectors, one male, one female
RET Interface Quantity	Three pairs of AISG 8 Pin DIN connectors, one per sector
RET Interface Location	On connector plate located at bottom of antenna
Electrical	
Input Voltage	10 - 30V
Power Idle Mode	< 1W
Power Active Mode	< 10W
Protocol	3GPP / AISG 2.0

TECHNICAL SPECIFICATION

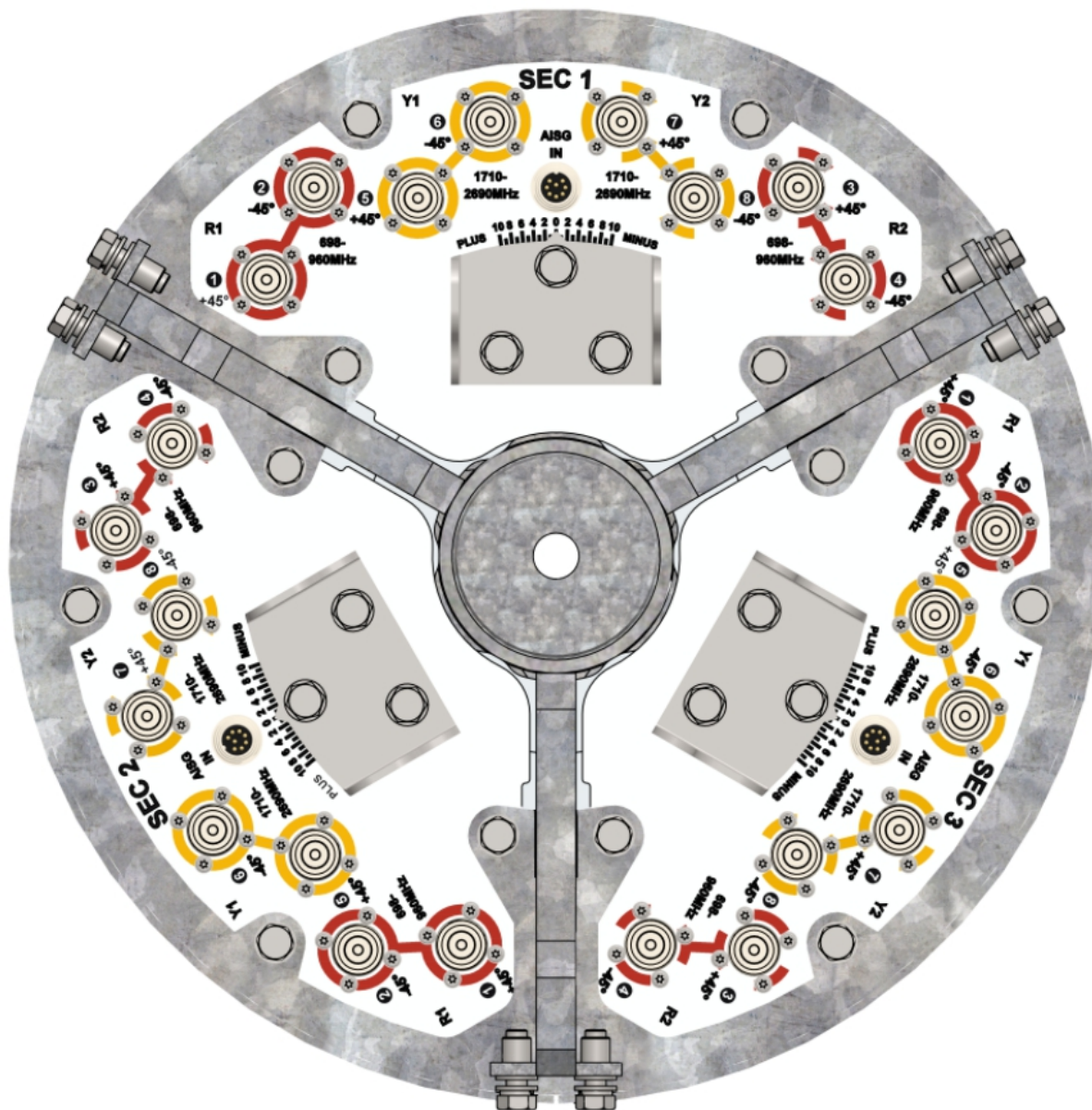
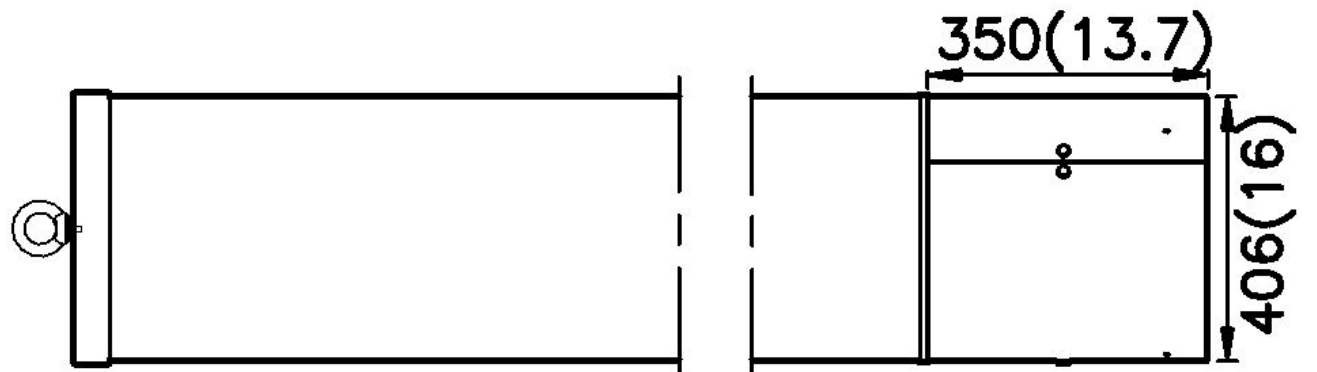
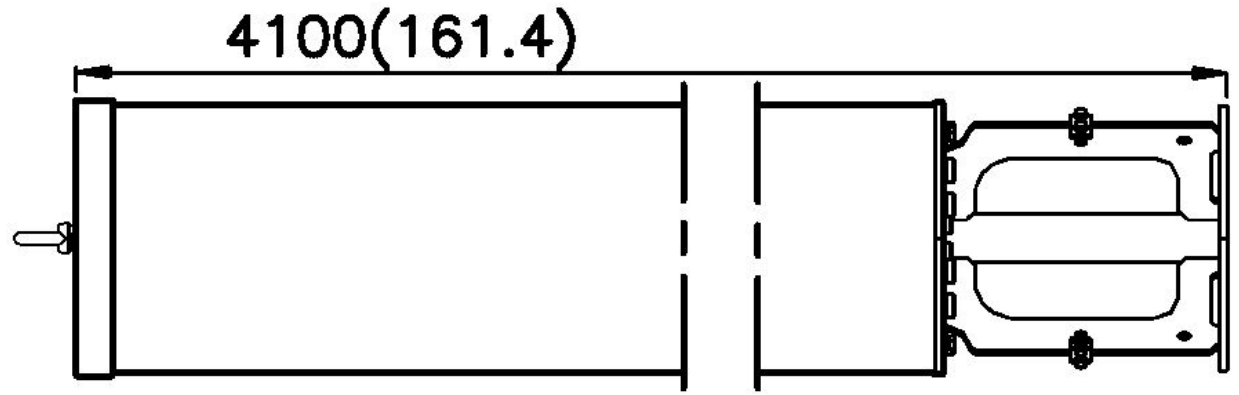
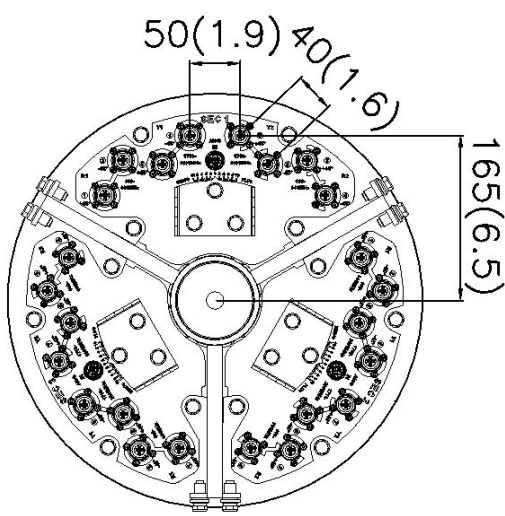

TECHNICAL SPECIFICATION

Mounting Bracket Kit

406mm Canister Flange Mount

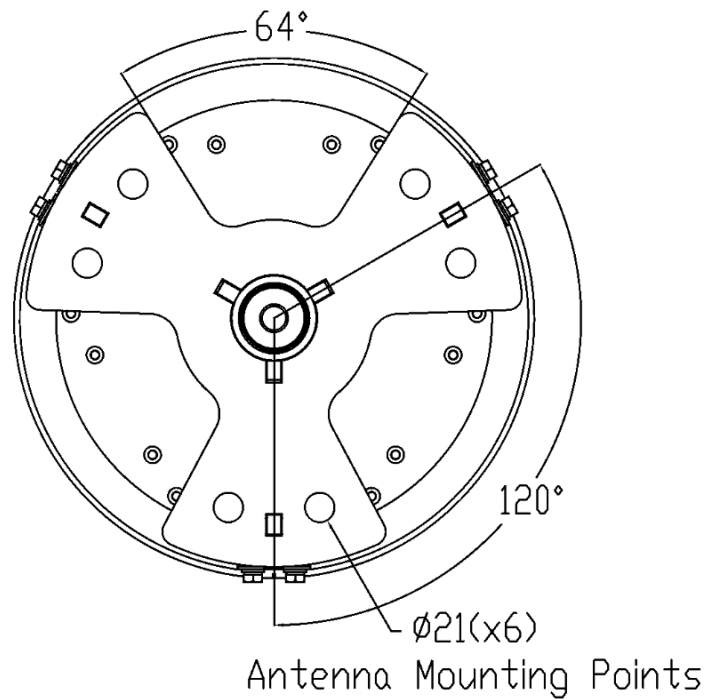

Mounting Kit Tilt Range	Mounting Kit Material	Mounting Kit Pole Diameter
N/A	Galvanized Steel	N/A

Ordering Info

Order Code - Antenna	Description
AW3707-E-F	Enclosed Remote Electrical Tilt (eRET) with 4.3-10 connectors.
Order Code - Accessories	Description
AW1012-2-FM-FM	RF Jumper Cable, connector types 4.3-10 (m) / 4.3-10 (m), length 2 metres (6'6")
AW1012-2-FM-NM	RF Jumper Cable, connector types 4.3-10 (m) / N-Type (m), length 2 metres (6'6")
AW1014-2-FM-TM	RF Jumper Cable, connector types 4.3-10 (m) / Nex10 (m), length 2 metres (6'6")
PADC 1000	Portable AISG Controller
SADC 2000	Site AISG Controller
AW0326-3-PM-PF	AISG Jumper Cable Lengths 3 metres (9' 10")
AW0326-10-PM-PF	AISG Jumper Cable Lengths 10 metres (32' 9")
AW0326-25-PM-PF	AISG Jumper Cable Lengths 25 metres (82')
AW0326-50-PM-PF	AISG Jumper Cable Lengths 50 metres (164')

Enquiries

Global Headquarters

Ashgrove Business Centre,
Ballybrittas, Portlaoise,
R32 DT0A, IRELAND
sales@alphawireless.com
+353 57 86 33847

North America

7301 W. 129th Street, Suite 150,
Overland Park,
KS 66213, USA
sales@alphawireless.com
+1 913 279 0008

Australia

3/76 Regentville Rd,
Jamisontown,
NSW 2750, AUSTRALIA
sales@alphawireless.com
+ 61 2 4504 8212

DISCLAIMER

The information in this document is provided solely regarding Alpha Wireless products. The information is not a guarantee of performance or characteristics. Alpha Wireless reserves the right to modify, change, amend, improve or make corrections to this document and its products, at any time and its sole discretion without prior written consent or notice. No license to any intellectual property rights is granted or implied under this document. Alpha Wireless disclaims warranties and liabilities of any kind including non-infringement of intellectual property rights of any third party.

© Alpha Wireless Limited 2022