



AW3893-E-C

Common Name 45 Port (2P/2P/2P/8P+1P x 3) Multiband Tri-Sector with 3.5GHz Beamforming

Frequency	Ports	Tilt	Gain	Beamwidth
698-960MHz	6	eRET	14.9	75°
1452-2400MHz	6	eRET	16.9	70°
1710-2690MHz	6	eRET	17.8	65°
3400-3800MHz	24 +3	eRET	15.5	90°

PRODUCT INFORMATION

This antenna solution is being deployed on rooftops and macro pole applications globally. It is a multi-frequency solution that provides 2 ports per sector across 698-960MHz, 2 ports per sector across 1452-2400MHz(L-Band), 2 ports per sector across 1710-2690MHz (Mid-Band) and 8 ports per sector across 3400-3800MHz. Each 3.5GHz sector is capable of Beamforming and has one additional Calibration Port per sector. The three sectors for each of the three bands fit in a 14.2 inch diameter canister to deliver a compact and aesthetically pleasing design.

APPLICATION

Canisters support multiple antennas into one attractive package. These canisters deliver an elegant macro solution for pole-top, rooftop and streetworks applications. Alpha Wireless produces one of the smallest diameter canisters in the marketplace. This canister is now 5G capable with the addition of 3.5GHz Beamforming sectors.



STANDARD & CERTIFICATIONS

Certification	BS EN ISO 9001:2015
---------------	---------------------



FEATURES

- Three sector canister with sectors orientated at 0°, 120° and 240° in the Azimuth Plane.
- 698-960MHz x 2 Ports per sector.
- 1452-2400MHz x 2 Ports per sector.
- 1710-2690MHz x 2 Ports per sector.
- 3400-3800MHz x 8 Ports per sector with Beamforming capability.
- Beamforming sectors have half lambda spacing between Radiator Columns.
- 698-960MHz tilt range T2° - T12°.
- 1452-2400MHz tilt range T2° - T12°.
- 1710-2690MHz tilt range T2° - T12°.
- 3400-3800MHz tilt range T0° - T10°.
- Low PIM performance to reduce interference.
- Flange mount design.

The parameters in this specification follow the definitions and recommendations per NGMN P-Basta, Release 9.6.

TECHNICAL SPECIFICATION

Electrical Specifications			Low Band			L- Band			Mid Band		
Frequency Range	MHz		698-790	790-890	890-960	1452-1492	1710-2170	2300-2400	1710-1920	1920-2170	2300-2690
Polarisation	Degree		+/- 45° Slant Linear								
Gain	Basta	dBi	14.2 ±0.5	14.3 ±0.5	14.4 ±0.5	15.7 ±0.5	16.4 ±0.5	16.2 ±0.5	16.8±0.5	17.1±0.5	17.3±0.5
	Max	dBi	14.7	14.8	14.9	16.2	16.9	16.7	17.3	17.6	17.8
Azimuth Beamwidth	Degree		78°	76°	73°	75°	70°	68°	69°	64°	60°
Azimuth Beam Squint	Degree<		3°			3°			3°		
Elevation Beamwidth	Degree		18.1°	16.4°	14.6°	7.0°	6.3°	6.2°	6.5°	6.2°	6.0°
Electrical Downtilt	Degree		T2° - T12°			T2° - T12°			T2° - T12°		
Electrical Downtilt Deviation	Degree<		1°								
Impedance	Ohms		50								
VSWR	<		1.5								
Return Loss	dB>		14								
Isolation	dB>		25								
Passive Intermodulation	dBc<		-150								
Upper Sidelobe Suppression, Peak to 20°	dB>		16								
Cross-Polar Discrimination	dB>		15			15			15		
Max Power Per Port	W		500			250			250		

Representative Pattern Files

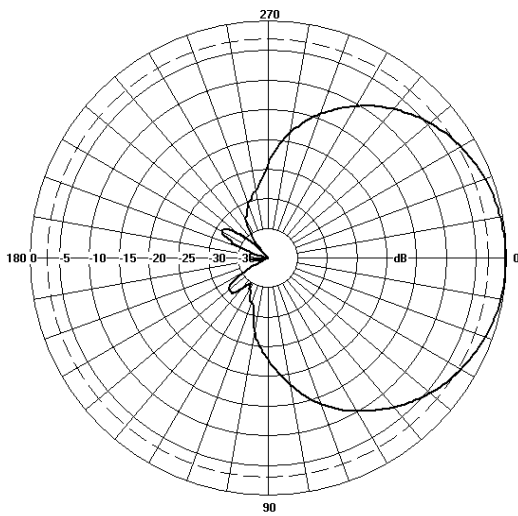

Azimuth

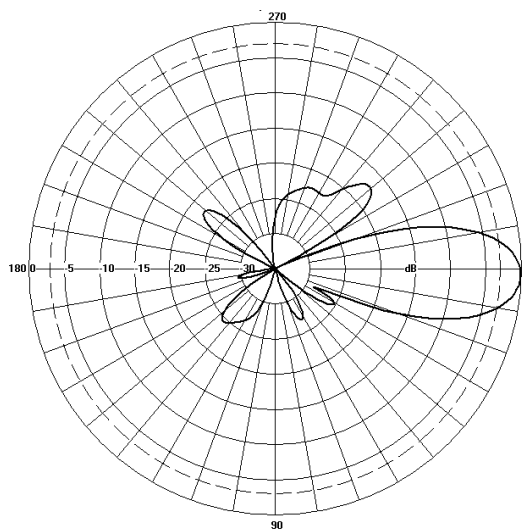

Low Band

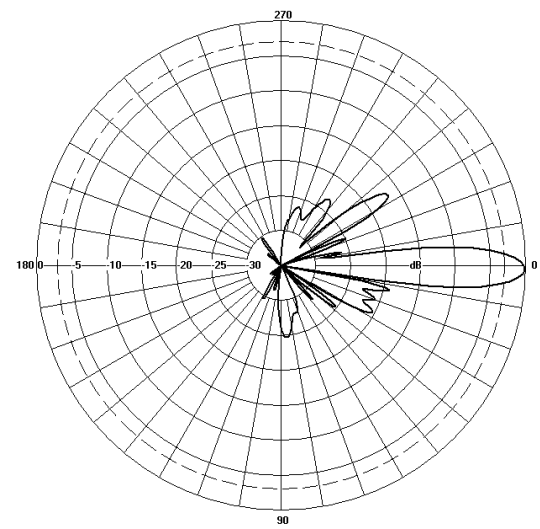

L- Band / Mid Band

Elevation

For radiation pattern files, please login at www.alphawireless.com

TECHNICAL SPECIFICATION

Electrical Specifications		3400 - 3800MHz Beamforming
Frequency Range	MHz	3400 - 3800MHz
Polarisation	Degree	+/- 45° Slant Linear
Gain		
Single Column	dBi	15.5 +/- 1
Broadcast Beam	dBi	16.5 +/- 1
Service Beam	dBi	20 +/- 1
Calibration Network		
Coupling Factor	dB	26 +/- 1
Max Amp Deviation	dB	0.7
Max Phase Deviation	dB <	5
Azimuth Beamwidth		
Single Column	3dB BW	90° +/- 15
Broadcast Beam	3dB BW	16.7
Service Beam	3dB BW	±30° ±1.5°
Azimuth Beam Squint	Degree <	5°
Elevation Beamwidth	Degree	6.5° ±1
Electrical Downtilt	Degree	T0° - T10°
Electrical Downtilt Deviation	Degree <	1°
Impedance	Ohms	50
VSWR	<	1.5
Return Loss	dB >	14
Isolation	dB >	25
Upper Sidelobe Suppression, Peak to 20°	dB >	16
Cross-Polar Discrimination	dB >	14
Maximum Effective Power Per Port	W	150

Radiation Pattern Files

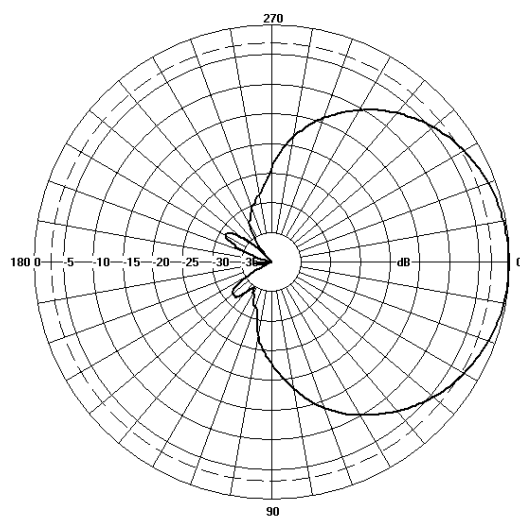

Azimuth

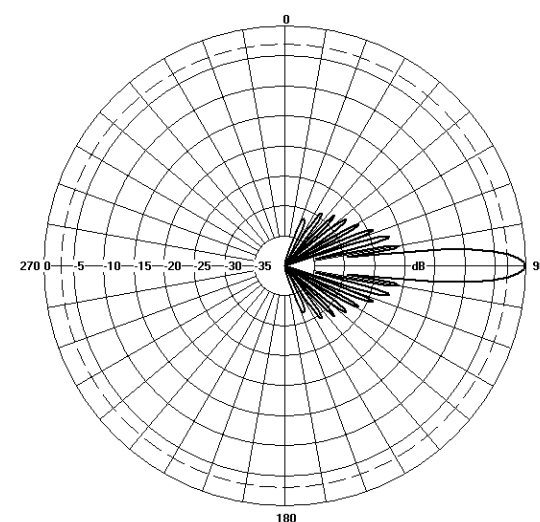
3.5GHz
Elevation

For radiation pattern files, please login at www.alphawireless.com

TECHNICAL SPECIFICATION

Mechanical Specifications		
Dimensions	mm (in)	2753 (108.3) x 360 (14.2) - (L x Ø)
Packing Size (LxWxD)	mm (in)	2910 (114) x 500 (20) x 590 (23)
Net Weight (antenna)	kg (lb)	105 (231.4)
Shipping Weight	kg (lb)	170(374.7)
Connector Type (Female)	-	698-960MHz / 1452-2690MHz uses 4.3-10 3.5GHz uses M-LOC Cluster Connector
Connector Position	-	Bottom
Connector Quantity	-	45 (6P Low band, 6P L Band,6P Mid band & 24 3.5GHz)+ 3 CAL ports
Windload Frontal (at Rated Wind Speed: 150km/h)	N (lbf)	885 (200)
Windload Lateral (at Rated Wind Speed: 150km/h)	N (lbf)	885 (200)
Survival Wind Speed	km/h (mph)	200 (125)
Radome Material	-	UV Stabilised ABS capped ASA
Radome Colour	RAL	7035 (light grey)
Product Compliance Environmental	-	RoHS
Lightning Protection	-	DC Grounded
Cold Temperature Survival	Celsius (Fahrenheit)	-40 (-40)
Hot Temperature Survival	Celsius (Fahrenheit)	70 (158)

Array Layout & RET Information

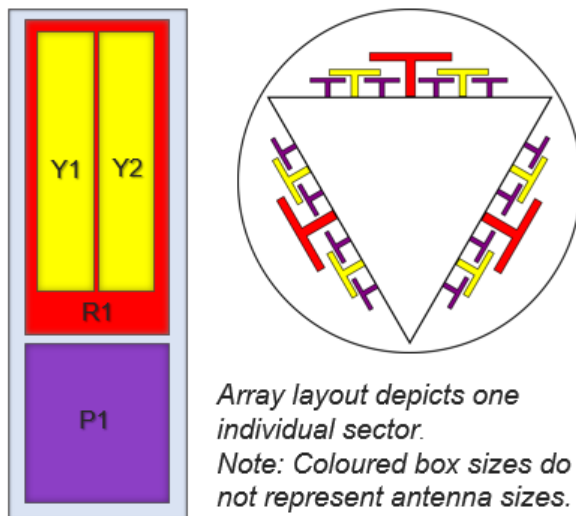

Array	Frequency MHz	Ports	RET ID
R1	698 - 960	1 - 2	1
Y1	1452 - 2400	3 - 4	2
Y2	1710 - 2690	5 - 6	3
P1	3400 - 3800	7 - 14	4

Configuration	
698-960 MHz	One RET per array: R1 x 3 Sectors
1452-2400 MHz	One RET per array: Y1 x 3 Sectors
1710-2690 MHz	One RET per array: Y2 x 3 Sectors
3400-3800 MHz	One RET per array: P1 x 3 Sectors
Total Quantity	Twelve RET Motor Controllers
Location and Interface	
RET Controller Location	Inside antenna radome housing
RET Interface	Pair of AISG 8 Pin DIN connectors, one male, one female
RET Interface Quantity	Three pairs of AISG 8 Pin DIN connectors, one per sector
RET Interface Location	On connector plate located at bottom of antenna
Electrical	
Input Voltage	10 - 30V
Power Idle Mode	< 1W
Power Active Mode	< 10W
Protocol	3GPP / AISG 2.0

TECHNICAL SPECIFICATION

Mechanical Illustration

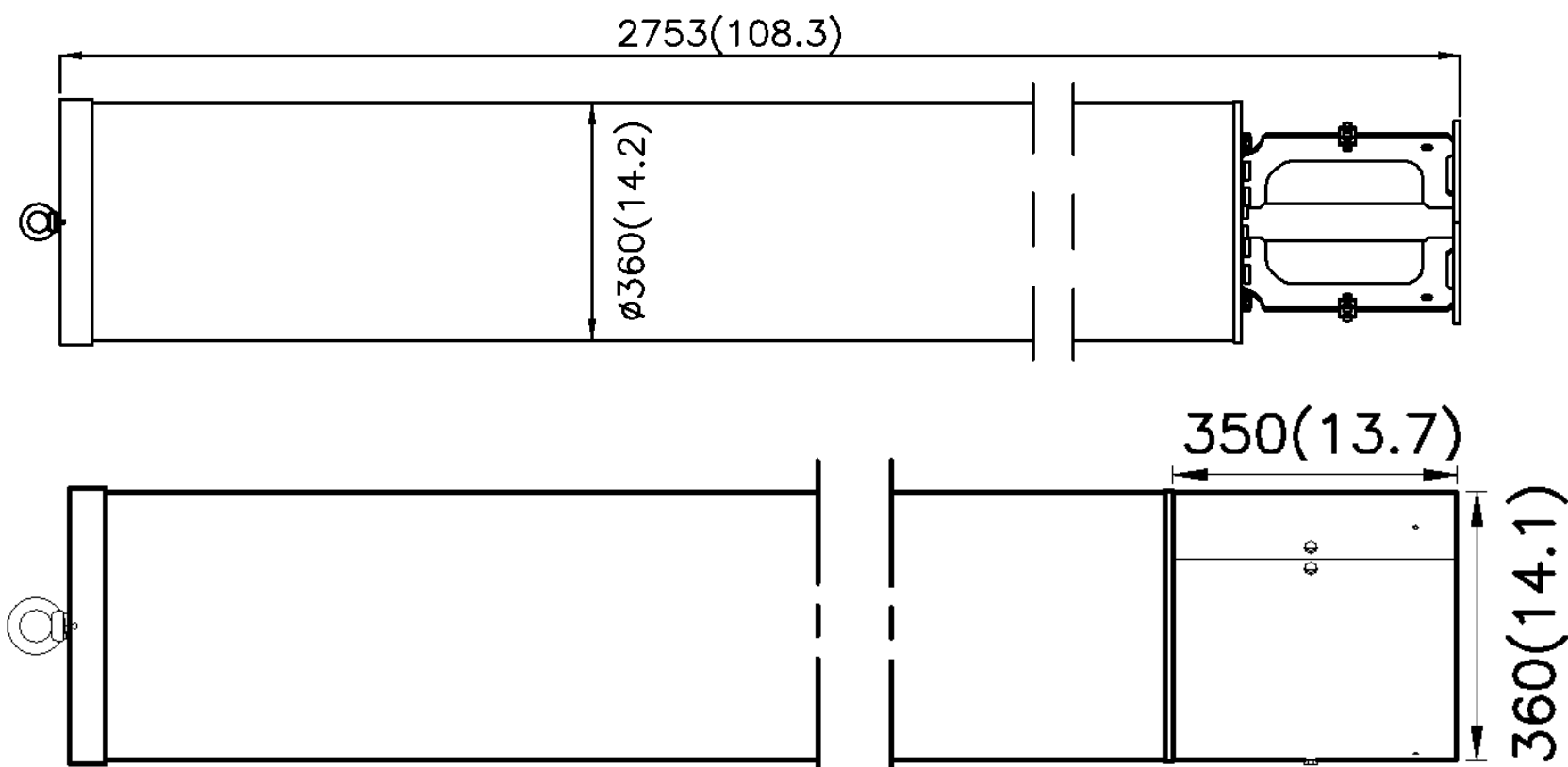
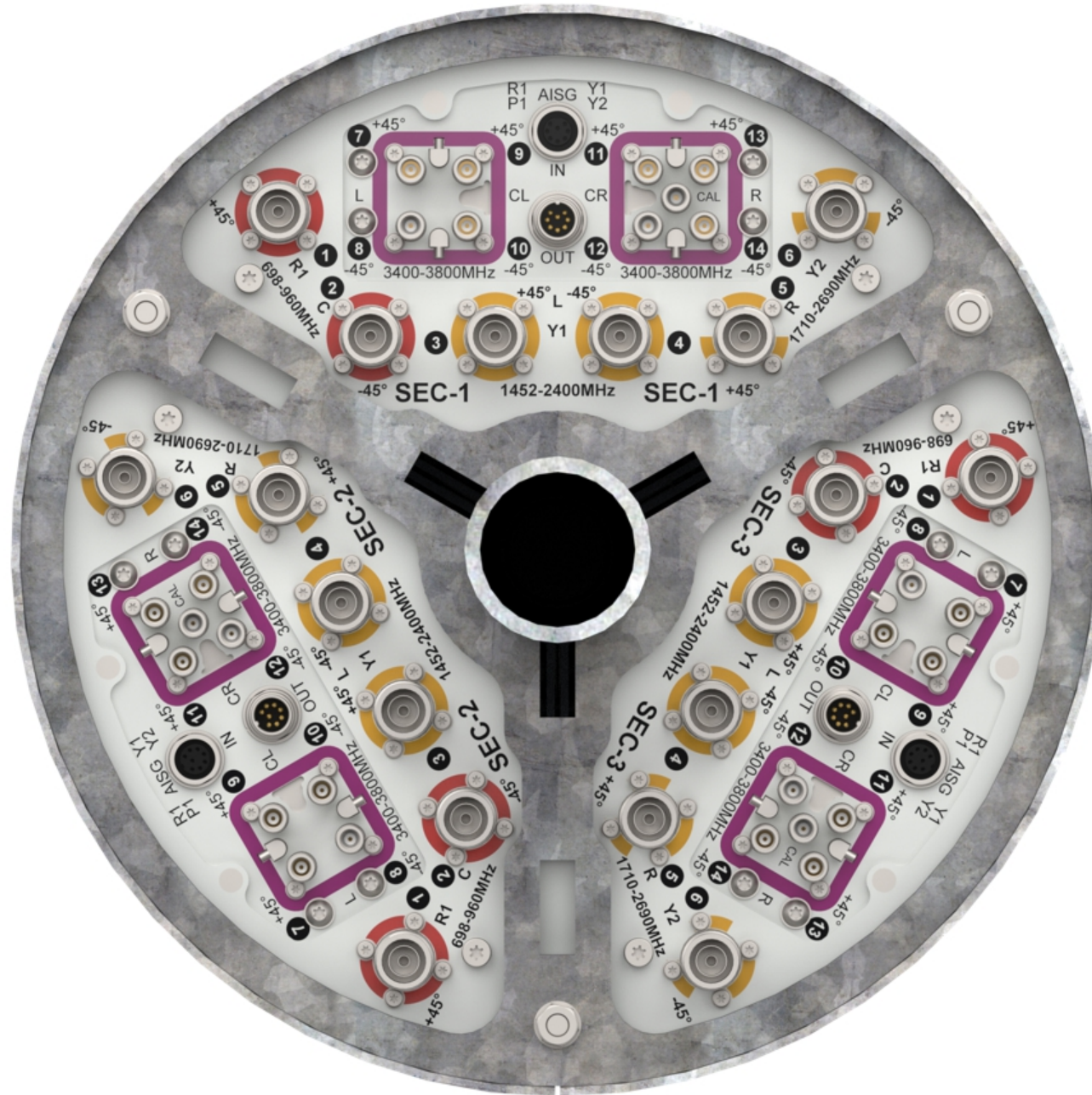

TECHNICAL SPECIFICATION

Mounting Bracket Kit

360mm Canister Flange Mount (Note: M18 Mounting Holes fit both 330mm and 360mm diameter canisters)

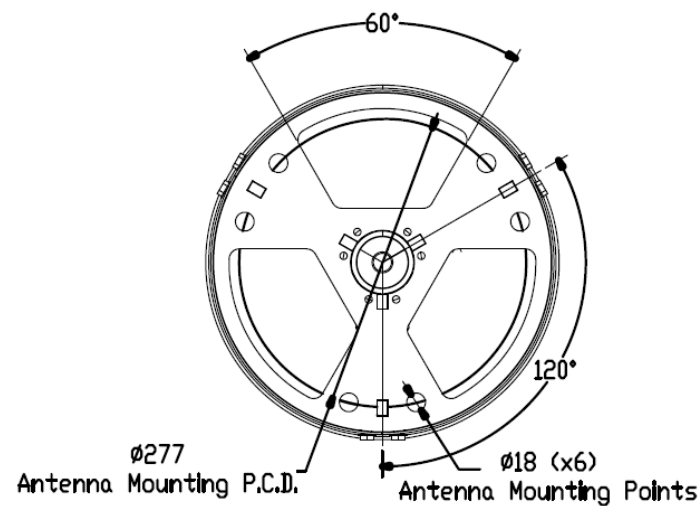

Mounting Kit Tilt Range	Mounting Kit Material	Mounting Kit Pole Diameter
N/A	Galvanized Steel	N/A

Ordering Info

Order Code - Antenna	Description
AW3893-E-C	Enclosed Remote Electrical Tilt (eRET) with MLOC and 4.3-10 Connectors
Order Code - Accessories	Description
AW1012-2-FM-FM	RF Jumper Cable, connector types 4.3-10 (m) / 4.3-10 (m), length 2 metres (6'6")
AW1012-2-FM-NM	RF Jumper Cable, connector types 4.3-10 (m) / N-Type (m), length 2 metres (6'6")
AW1014-2-FM-TM	RF Jumper Cable, connector types 4.3-10 (m) / Nex10 (m), length 2 metres (6'6")
PADC 1000	Portable AISG Controller
SADC 2000	Site AISG Controller
AW0326-3-PM-PF	AISG Jumper Cable Lengths 3 metres (9' 10")
AW0326-10-PM-PF	AISG Jumper Cable Lengths 10 metres (32' 9")
AW0326-25-PM-PF	AISG Jumper Cable Lengths 25 metres (82')
AW0326-50-PM-PF	AISG Jumper Cable Lengths 50 metres (164')

Enquiries

Global Headquarters
Ashgrove Business Centre,
Ballybrittas, Portlaoise,
R32 DT0A, IRELAND
sales@alphawireless.com
+353 57 86 33847

North America
7301 W. 129th Street, Suite 150,
Overland Park,
KS 66213, USA
sales@alphawireless.com
+1 913 279 0008

Australia
3/76 Regentville Rd,
Jamisontown,
NSW 2750, AUSTRALIA
sales@alphawireless.com
+ 61 2 4504 8212

DISCLAIMER

The information in this document is provided solely regarding Alpha Wireless products. The information is not a guarantee of performance or characteristics. Alpha Wireless reserves the right to modify, change, amend, improve or make corrections to this document and its products, at any time and its sole discretion without prior written consent or notice. No license to any intellectual property rights is granted or implied under this document. Alpha Wireless disclaims warranties and liabilities of any kind including non-infringement of intellectual property rights of any third party.

© Alpha Wireless Limited 2022