



AW3910-E-F

Common Name 18 Port (2P/4P x 3) Low Band, Mid Band Tri-Sector

698-960MHz	6	eRET	14.4	65°
1710-2690MHz	12	eRET	17.8	65°
Frequency	Ports	Tilt	Gain	Beamwidth

PRODUCT INFORMATION

This antenna solution is being deployed on rooftops and macro pole applications globally. It is a multi-frequency solution that provides 2 ports per sector across 698-960MHz (Low Band) and 4 ports per sector across 1710-2690MHz (Mid Band). The three sectors fit in a 14.2 Inch diameter canister to deliver a compact and aesthetically pleasing solution. The three 65 degree azimuth beamwidth sectors are positioned at 0°, 120°, and 240° in the azimuth plane.

APPLICATION

Canisters support multiple antennas into one attractive package. These canisters deliver an elegant macro solution for pole-top, rooftop and streetworks applications. Alpha Wireless produces one of the smallest diameter canisters in the marketplace.

STANDARD & CERTIFICATIONS

Certification	BS EN ISO 9001:2015
---------------	---------------------



FEATURES

- Three sector canister with sectors orientated at 0°, 120°, and 240° in the Azimuth Plane
- 698-960MHz x 2 Ports per sector
- 1710-2690MHz x 4 Ports per sector
- 698-960MHz tilt range T2° - T12°.
- 1710-2690MHz tilt range T2° - T12°.
- Low PIM performance to reduce interference.
- Seamless access hatch cover that hides the jumper cables.
- Flange mount design.

The parameters in this specification follow the definitions and recommendations per NGMN P-Basta, Release 9.6.

TECHNICAL SPECIFICATION

Electrical Specifications		Low Band			Mid Band			
Frequency Range	MHz	698-790	790-890	890-960	1710-1920	1920-2170	2300-2690	
Polarisation	Degree	±45° Slant Linear						
Gain	Basta	dBi	13.5±0.5	13.8±0.5	13.9±0.5	16.8±0.5	17.1±0.5	17.3±0.5
	Max	dBi	14.0	14.3	14.4	17.3	17.6	17.8
Azimuth Beamwidth	Degree	78°	76°	73°	61°	62°	62°	
Azimuth Beam Squint	Degree<	3°			3°			
Elevation Beamwidth	Degree	18.1°	16.4°	14.6°	7.5°	6.7°	5.7°	
Electrical Downtilt	Degree	T2° - T12°			T2° - T12°			
Electrical Downtilt Deviation	Degree<	1°	1°	1°	1°	1°	1°	
Impedance	Ohms	50						
VSWR	<	1.5						
Return Loss	dB>	14						
Isolation	dB>	25	25	25	25	25	25	
Passive Intermodulation	dBc<	-150	-150	-150	-150	-150	-150	
Upper Sidelobe Suppression, Peak to 20°	dB>	16	16	16	16	16	16	
Cross-Polar Discrimination	dB>	15	15	15	15	15	15	
Max Power Per Port	W	300			250			

Representative Pattern Files

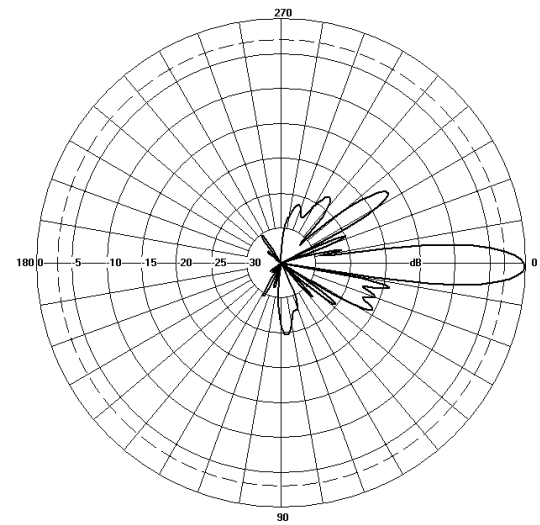
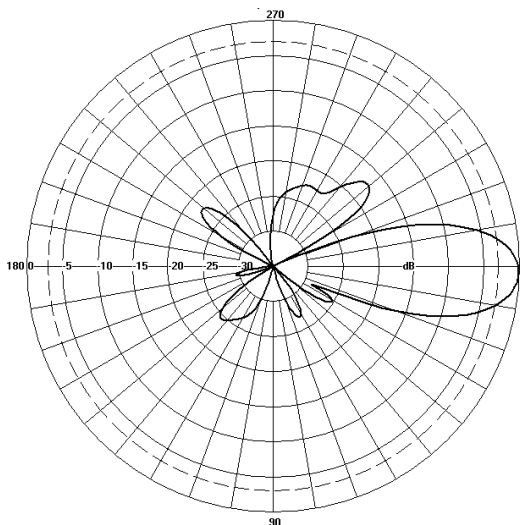
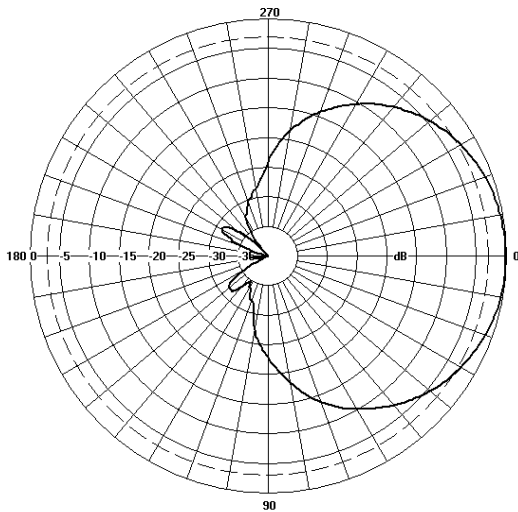

Azimuth

Elevation

For radiation pattern files, please login at www.alphawireless.com

TECHNICAL SPECIFICATION

Mechanical Specifications

Dimensions	mm (in)	1800 (70.9) x 360 (14.2) - (L x Ø)
Packing Size (LxWxD)	mm (in)	1957 (77.0) x 500 (20) x 590 (23)
Net Weight (antenna)	kg (lb)	55 (121)
Shipping Weight	kg (lb)	95 (210)
Connector Type (Female)	-	4.3-10
Connector Position	-	Bottom
Connector Quantity	-	18 (6P Low band, 12P Mid band)
Windload Frontal (at Rated Wind Speed: 150km/h)	N (lbf)	530 (120)
Windload Lateral (at Rated Wind Speed: 150km/h)	N (lbf)	530 (120)
Survival Wind Speed	km/h (mph)	200 (125)
Radome Material	-	UV Stabilised ABS capped ASA
Radome Colour	RAL	7035 (light grey)
Product Compliance Environmental	-	RoHS
Lightning Protection	-	DC Grounded
Cold Temperature Survival	Celsius (Fahrenheit)	-40 (-40)
Hot Temperature Survival	Celsius (Fahrenheit)	70 (158)

Array Layout and RET Information

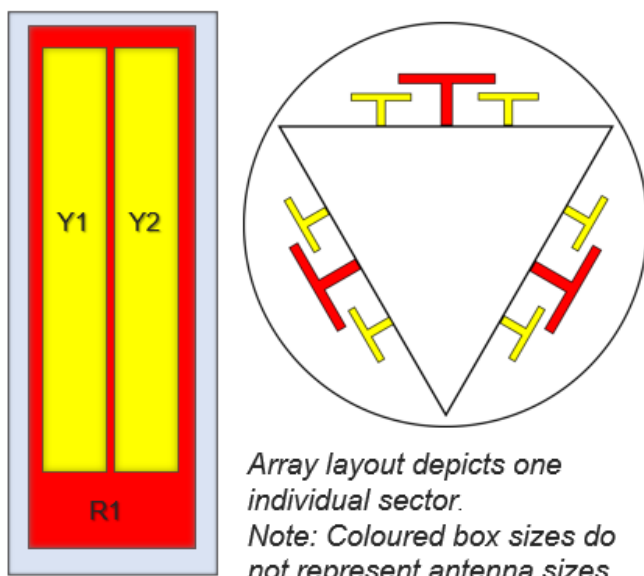

Array	Frequency MHz	Ports	RET ID
R1	698 - 960	1 - 2	1
Y1	1710 -2690	3 - 4	2
Y2		5 - 6	3

Configuration	
698-960 MHz	One RET per array: R1 x 3 Sectors
1710-2690 MHz	One RET per array: Y1, Y2 x 3 Sectors
Total Quantity	Nine RET Motor Controllers
Location and Interface	
RET Controller Location	Inside antenna radome housing
RET Interface	Pair of AISG 8 Pin DIN connectors, one male, one female
RET Interface Quantity	Three pairs of AISG 8 Pin DIN connectors, one per sector
RET Interface Location	On connector plate located at bottom of antenna
Electrical	
Input Voltage	10 - 30V
Power Idle Mode	< 1W
Power Active Mode	< 10W
Protocol	3GPP / AISG 2.0

TECHNICAL SPECIFICATION

Mechanical Illustration

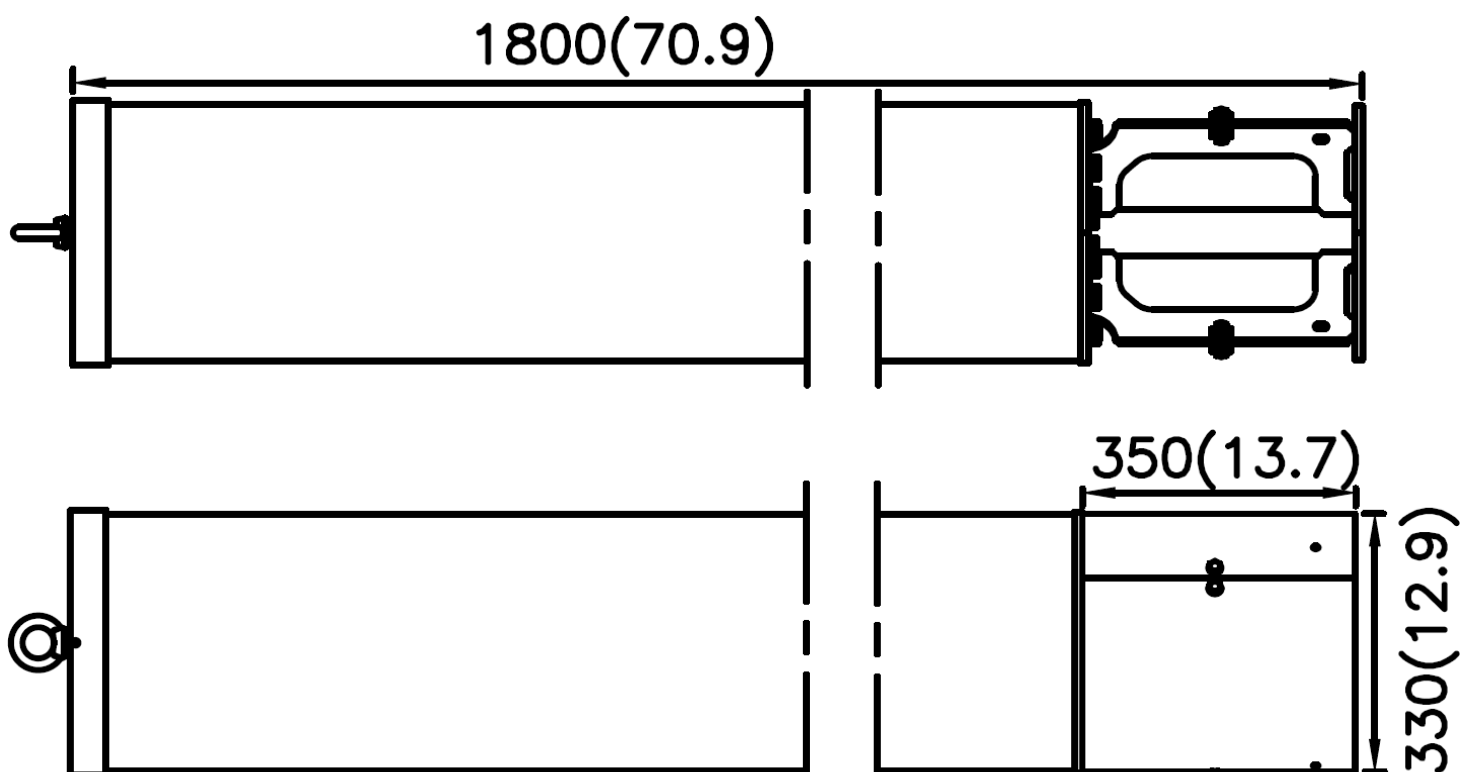
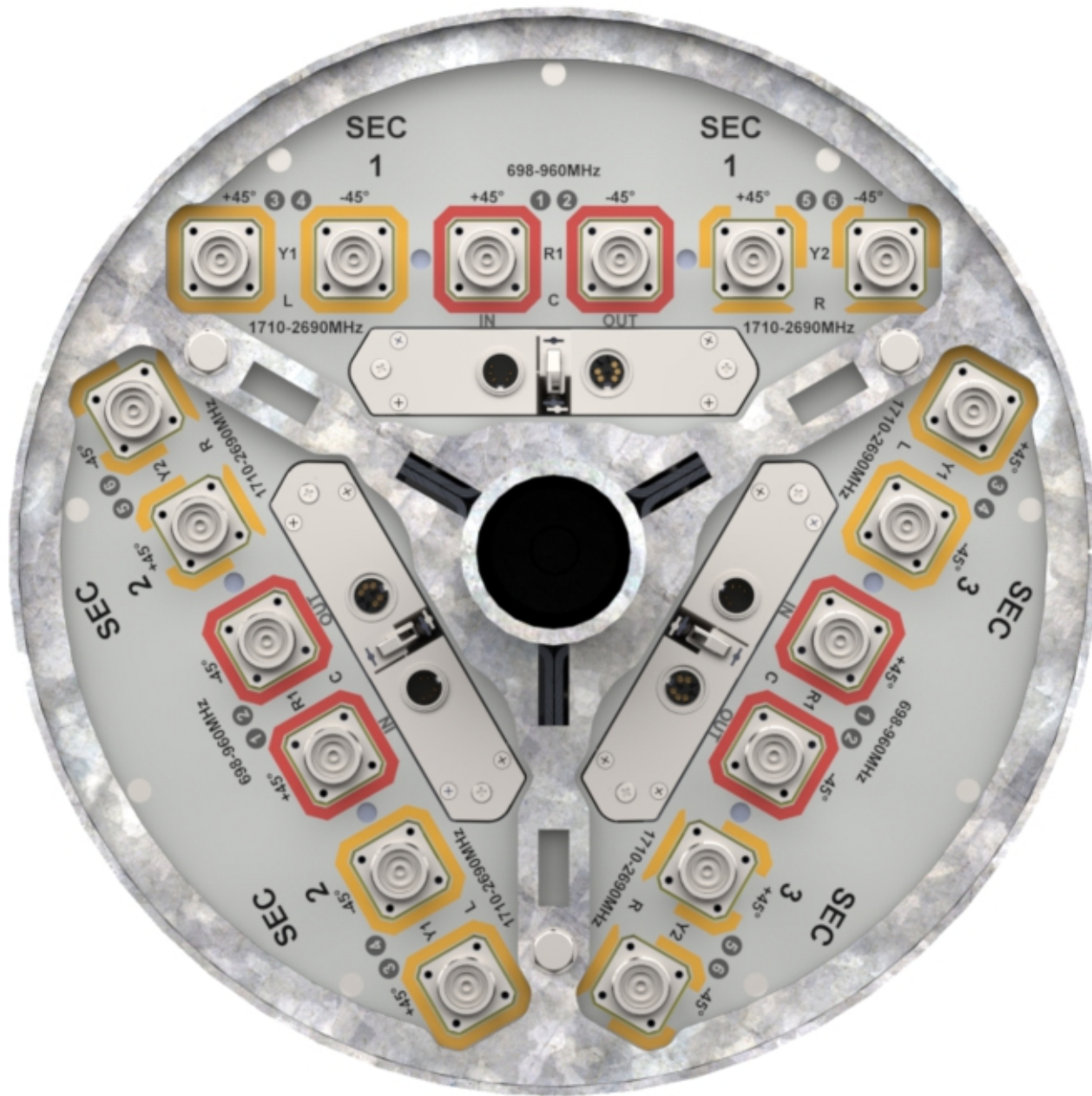

TECHNICAL SPECIFICATION

Mounting Bracket Kit

360mm Canister Flange Mount (Note: Mounting Holes fit both 330mm and 360mm diameter canisters)

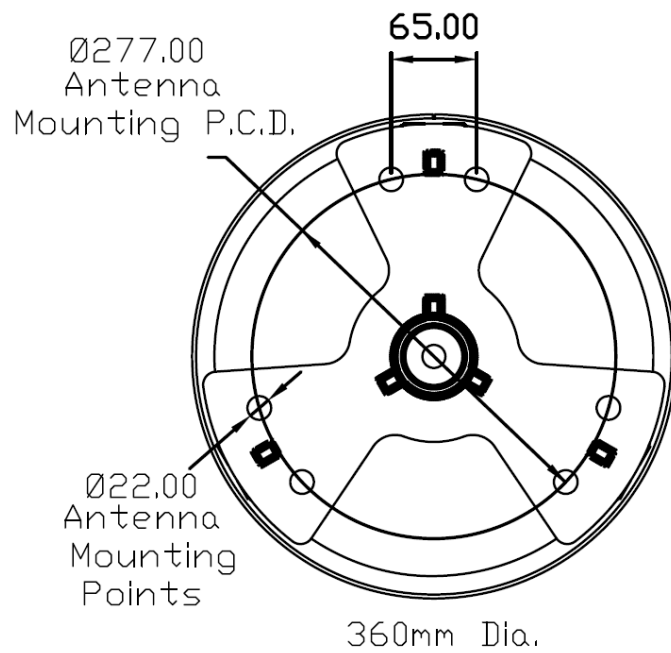

Mounting Kit Tilt Range	Mounting Kit Material	Mounting Kit Pole Diameter
N/A	Galvanized Steel	N/A

Ordering Info

Order Code - Antenna	Description
AW3910-E-F	Enclosed Remote Electrical Tilt (eRET) with 4.3-10 Connectors.
Order Code - Accessories	Description
AW1012-2-FM-FM	RF Jumper Cable, connector types 4.3-10 (m) / 4.3-10 (m), length 2 metres (6'6")
AW1012-2-FM-NM	RF Jumper Cable, connector types 4.3-10 (m) / N-Type (m), length 2 metres (6'6")
AW1014-2-FM-TM	RF Jumper Cable, connector types 4.3-10 (m) / Nex10 (m), length 2 metres (6'6")
PADC 1000	Portable AISG Controller
SADC 2000	Site AISG Controller
AW0326-3-PM-PF	AISG Jumper Cable Lengths 3 metres (9' 10")
AW0326-10-PM-PF	AISG Jumper Cable Lengths 10 metres (32' 9")
AW0326-25-PM-PF	AISG Jumper Cable Lengths 25 metres (82')
AW0326-50-PM-PF	AISG Jumper Cable Lengths 50 metres (164')

Enquiries

Global Headquarters
 Ashgrove Business Centre,
 Ballybrittas, Portlaoise,
 R32 DTOA, IRELAND
sales@alphawireless.com
 +353 57 86 33847

North America
 7301 W. 129th Street, Suite 150,
 Overland Park,
 KS 66213, USA
sales@alphawireless.com
 +1 913 279 0008

Australia
 3/76 Regentville Rd,
 Jamisontown,
 NSW 2750, AUSTRALIA
sales@alphawireless.com
 + 61 2 4504 8212

DISCLAIMER

The information in this document is provided solely regarding Alpha Wireless products. The information is not a guarantee of performance or characteristics. Alpha Wireless reserves the right to modify, change, amend, improve or make corrections to this document and its products, at any time and its sole discretion without prior written consent or notice. No license to any intellectual property rights is granted or implied under this document. Alpha Wireless disclaims warranties and liabilities of any kind including non-infringement of intellectual property rights of any third party.

© Alpha Wireless Limited 2022